



QPA10... / QPA20...



QPA20...D

## Room air quality sensors

**QPA10...**  
**QPA20...**

- maintenance-free CO<sub>2</sub> sensing element (depending on type) based on optical infrared absorption measurement (NDIR<sup>1</sup>)
- or with VOC<sup>2</sup> sensing element based on a heated tin dioxide semiconductor
- CO<sub>2</sub> temperature (active or passive) and CO<sub>2</sub> humidity-temperature multisensor
- No recalibrations required
- Operating voltage AC 24 V or DC 15...35 V
- Signal outputs DC 0...10 V or DC 0...5 V adjustable
- Selectable passive temperature sensing element

1) NDIR = Non dispersive infrared

2) VOC = volatile organic compounds (also called mixed gas)

### Use

In ventilation and air conditioning plants to enhance room comfort and optimize energy consumption by providing demand-controlled ventilation. The sensor acquires:

- CO<sub>2</sub> concentrations as an indication of occupancy in rooms where smoking is prohibited.
- VOC concentrations as an indication of odors such as tobacco smoke, body odor, or material fumes in the room.
- Relative humidity in the room.
- Room temperature.

Sensors QPA10... and QPA20... can be used as a:

- Control sensor.
- Transmitter for building automation and control systems and / or display units (QPA20...D only).

Typical use:

- Acquisition of CO<sub>2</sub> and VOC concentrations:  
In party rooms, lounges, fair pavilions and exhibition halls, restaurants, canteens, shopping malls, athletic centers, sales rooms, and conference rooms.

Архангельск (8182)63-90-72  
Астана +7(7172)727-132  
Белгород (4722)40-23-64  
Брянск (4832)59-03-52  
Владивосток (423)249-28-31  
Волгоград (844)278-03-48  
Вологда (8172)26-41-59  
Воронеж (473)204-51-73  
Екатеринбург (343)384-55-89  
Иваново (4932)77-34-06  
Ижевск (3412)26-03-58  
Казань (843)206-01-48

Калининград (4012)72-03-81  
Калуга (4842)92-23-67  
Кемерово (3842)65-04-62  
Киров (8332)68-02-04  
Краснодар (861)203-40-90  
Красноярск (391)204-63-61  
Курск (4712)77-13-04  
Липецк (4742)52-20-81  
Магнитогорск (3519)55-03-13  
Москва (495)268-04-70  
Мурманск (8152)59-64-93  
Набережные Челны (8552)20-53-41

Нижний Новгород (831)429-08-12  
Новокузнецк (3843)20-46-81  
Новосибирск (383)227-86-73  
Орел (4862)44-53-42  
Оренбург (3532)37-68-04  
Пенза (8412)22-31-16  
Пермь (342)205-81-47  
Ростов-на-Дону (863)308-18-15  
Рязань (4912)46-61-64  
Самара (846)206-03-16  
Санкт-Петербург (812)309-46-40  
Саратов (845)249-38-78

Смоленск (4812)29-41-54  
Сочи (862)225-72-31  
Ставрополь (8652)20-65-13  
Тверь (4822)63-31-35  
Томск (3822)98-41-53  
Тула (4872)74-02-29  
Тюмень (3452)66-21-18  
Ульяновск (8422)24-23-59  
Уфа (347)229-48-12  
Челябинск (351)202-03-61  
Череповец (8202)49-02-64  
Ярославль (4852)69-52-93

- Acquisition of CO<sub>2</sub> concentrations:  
In rooms with varying occupancy levels where smoking is prohibited, e.g. museums, theaters, movie theaters, auditoriums, office spaces, and school rooms.

Important!

QPA20... sensors may not be deployed as safety devices, e.g. as gas or smoke warning devices!

### Type summary

| Product number  | CO <sub>2</sub> measuring range | VOC time constant                     | Temperature measuring range            | Humidity measuring range | Display of measured value |
|-----------------|---------------------------------|---------------------------------------|--|--------------------------|---------------------------|
| <b>QPA1000</b>  | ---                             | Slow (R1)<br>Normal (R2)<br>Fast (R3) | ---                                    | ---                      | ---                       |
| <b>QPA2000</b>  | 0...2000 ppm                    | ---                                   | ---                                    | ---                      | No                        |
| <b>QPA2002</b>  | 0...2000 ppm                    | Slow (R1)<br>Normal (R2)<br>Fast (R3) | ---                                    | ---                      | No                        |
| <b>QPA2002D</b> | 0...2000 ppm                    | Slow (R1)<br>Normal (R2)<br>Fast (R3) | ---                                    | ---                      | Yes                       |
| <b>QPA2060</b>  | 0...2000 ppm                    | ---                                   | 0...50 °C / -35...+35 °C               | ---                      | No                        |
| <b>QPA2060D</b> | 0...2000 ppm                    | ---                                   | 0...50 °C / -35...+35 °C               | ---                      | Yes                       |
| <b>QPA2062</b>  | 0...2000 ppm                    | ---                                   | 0...50 °C / -35...+35 °C               | 0...100 %                | No                        |
| <b>QPA2062D</b> | 0...2000 ppm                    | ---                                   | 0...50 °C / -35...+35 °C               | 0...100 %                | Yes                       |
| <b>QPA2080</b>  | 0...2000 ppm                    | ---                                   | Depending on connected sensing element | ---                      | No                        |
| <b>QPA2080D</b> | 0...2000 ppm                    | ---                                   | Depending on connected sensing element | ---                      | Yes*                      |

\* The passive temperature measured value is not displayed

### Ordering

When ordering, please give name and product number, e.g.:  
Room air quality sensor **QPA2002**

### Equipment combinations

All systems and devices capable of processing the following sensor signals:

- DC 0...10 V or DC 0...5 V or
- passive sensor signals for sensor QPA2080...

### Mode of operation

#### CO<sub>2</sub> concentrations

Symaro™ air quality sensors acquire the CO<sub>2</sub> concentration by infrared absorption measurement (NDIR). Due to an additional integrated reference light source, the measurement is always accurate and no service or recalibration needed, thus reducing service costs. The resulting output signal DC 0...10 V or DC 0...5 V is proportionate to the CO<sub>2</sub> content of ambient air.

Function diagram CO<sub>2</sub>  
(output U1)

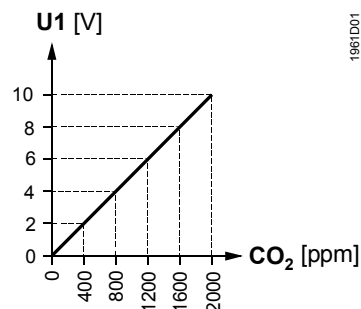

1961001

**VOC concentration  
(QPA1000)**

Symaro™ air quality sensors determine the mixed gas concentration (VOC) using metal-oxide semiconductor sensing elements. The sensors measure precisely at all times and with no maintenance and recalibration required thanks to an integrated compensation mechanism, saving service costs. The sensor provides a DC 0...10 V or DC 0...5 V output signal proportionate to the VOC content of the ambient air.

*Diagram VOC  
(Output U1)*

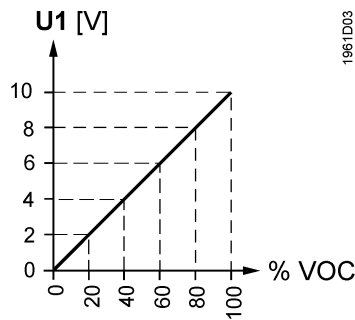

*Time constant  
"VOC signal"*

Select the time constant for VOC measurement by limiting the maximum slew rate for the VOC signal. The jumper X4 (measuring range) fine tunes the time constant for VOC ventilation demand.

The center position (R2) produces a normal slew rate of max. 10% change to the VOC signal per minute (factory setting). The other 2 position reduce (R1, 2.5% VOC/min) or increase (R3, 40% VOC/min) the maximum slew rate. A smaller slew rate (R1) filters out short-term VOC concentration peaks, e.g. caused by a highly perfumed person passing by. The sensor reacts immediately and quickly to changes in VOC concentration at the higher slew rate (R3).

Time constant  $t_{63}$  selected by jumper X4 corresponds to <13 min (R1), <3.5 min (R2), or <1 min (R3) for a sudden change to 50% VOC.

**CO<sub>2</sub>/VOC concentration  
(QPA2002 and QPA2002D)**

The sensor acquires and evaluates the CO<sub>2</sub> / VOC concentration and transforms it to a ventilation demand signal.

It represents the result of maximum selection of the CO<sub>2</sub> measuring signal and the filtered VOC measuring signal. With maximum selection, the 2 demand signals are compared and provided as common air quality demand.

The ventilation demand signal is provided via output U2 as a DC 0...10 V or DC 0...5 V -signal to be supplied to the ventilation controller.

*Ventilation demand  
diagram (output U2)*

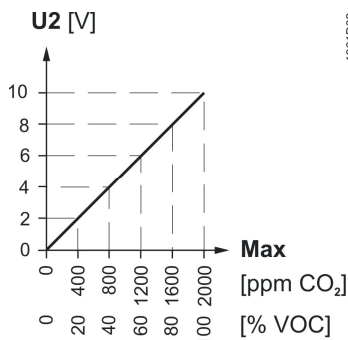

**Relative humidity  
(QPA2062 and  
QPA2062D)**

The sensor acquires the relative humidity in the room with a capacitive humidity sensing element whose capacitance changes as a function of relative humidity.

An electronic measuring circuit converts the signal from the sensing element to a continuous DC 0...10 V or DC 0...5 V signal, corresponding to a relative humidity range of 0...100 %.

**Temperature active  
(QPA206...)**

The sensor acquires the room temperature with a sensing element whose electrical resistance changes as a function of the temperature.  
The change is converted to an active DC 0...10 V or DC 0...5 V output signal  
( $\cong 0...50\text{ }^{\circ}\text{C}$  or  $-35...+35\text{ }^{\circ}\text{C}$ ).

**Temperature passive  
(QPA2080...)**

The sensor measures the room temperature using a sensing element where electrical resistance changes with the temperature of the ambient air.  
The sensing element is on the device's rear side and connected at the appropriate connection terminals.  
The following sensing elements are included with the device:  
- LG-Ni1000  
- Pt1000  
- Pt100  
- NTC 10kOhm

**Sensing element**

*LG-Ni 1000:*

Characteristic curve:

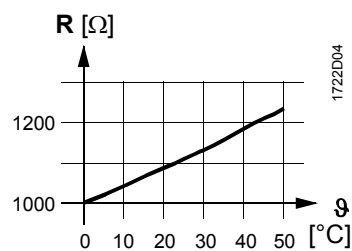

Accuracy:

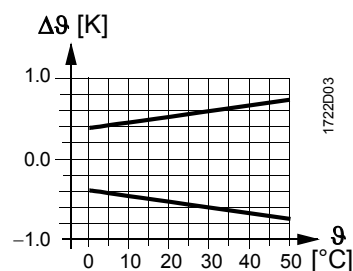

*Pt 1000 (Kl. B)*

Characteristic curve:

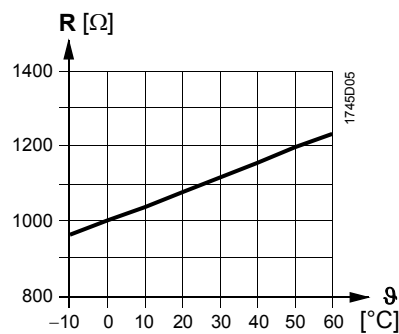

Accuracy:

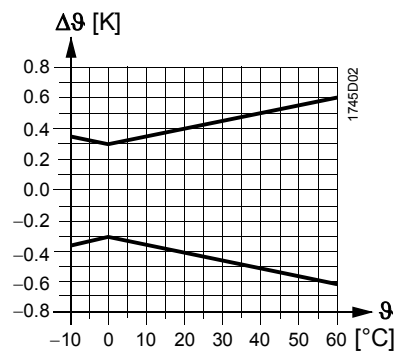

*Pt 100 (Kl. B)*

Characteristic curve:

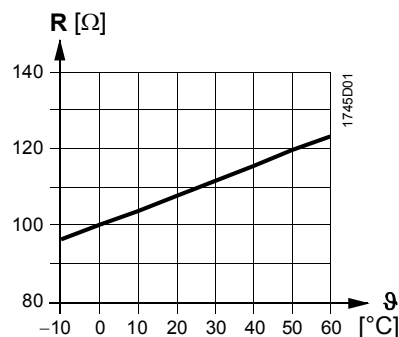

Accuracy:

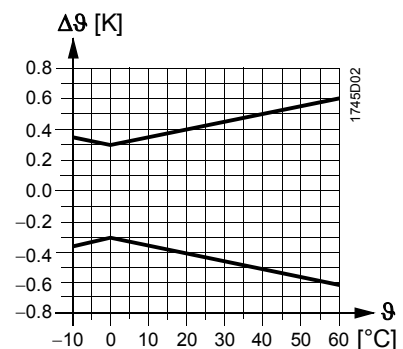

NTC 10k

Characteristic curve:

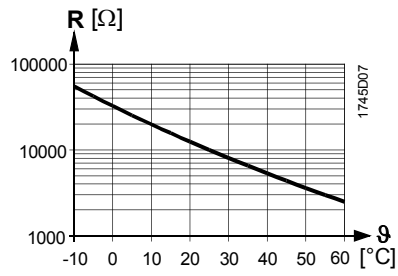

Accuracy:

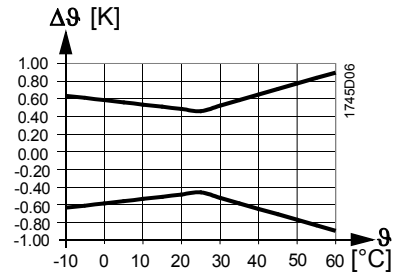

Key

- R Resistance in Ohm
- $\theta$  Temperature in Celsius
- $\Delta\theta$  Temperature differential in Kelvin

### Mechanical design

---

The units are designed for wall mounting and can be deployed with most types of commercially available recessed conduit boxes. The cables can be introduced from the rear (concealed wiring), from below or above (surface-run wires) through knockout openings.

The units consist of 2 major sections: Casing and base plate. Both snap together but can be detached again.

The measuring circuit, the sensing elements, and the setting elements are located on a printed circuit board in the unit.

The mounting base carries the connection terminals.

---

Setting elements...

QPA2000/2060/2060D  
QPA2080/QPA2080D

| Measuring range<br>Output voltage |       | Test function active |      |      |
|-----------------------------------|-------|----------------------|------|------|
| R1                                | R2    | X4                   | U1   | U2   |
| Upper                             | Mid   | Upper                | 10 V | 5 V  |
| Mid                               | Lower | Mid                  | 0 V  | 5 V  |
| Lower                             | Upper | Lower                | 5 V  | 10 V |
| Upper                             | Mid   | Upper                | 5 V  | 0 V  |

Display Temperature unit  
°F  
°C

1961Z04en

QPA1000  
QPA2002/QPA2002D  
QPA2062/QPA2062D

| Measuring range |       | * Test function active |      |      |     |
|-----------------|-------|------------------------|------|------|-----|
| R1              | R2    | X4                     | U1   | U2   | U3  |
| Upper           | Mid   | Upper                  | 10 V | 5 V  | 5 V |
| Mid             | Lower | Mid                    | 0 V  | 5 V  | 5 V |
| Lower           | Upper | Lower                  | 5 V  | 10 V | 5 V |
| Upper           | Mid   | Upper                  | 5 V  | 0 V  | 5 V |

| X17   | U1  | U2  | U3   |
|-------|-----|-----|------|
| Upper | 5 V | 5 V | 10 V |
| Mid   | 5 V | 5 V | 0 V  |
| Lower | 5 V | 5 V | 5 V  |
| Upper | 5 V | 5 V | 5 V  |

Output voltage  
R4, R5, R6 X17

Display Temperature unit  
°F  
°C

\* Set either X4 or X17 into test function, but not both at the same time.

The setting elements can be accessed after removing the mounting base.

... for the measuring range

Meaning of the different jumper positions:

with **QPA2000**

- For the CO<sub>2</sub> measuring range:  
Jumper in the mid position (R2) = 0...2000 ppm (factory setting)

with **QPA1000, QPA2002 and QPA2002D**

- For VOC:
  - Jumper in the upper position (R1) = VOC time constant "slow"
  - Jumper in the mid position (R2) = VOC time constant "normal" (factory setting)
  - Jumper in the lower position (R3) = VOC time constant "fast"

with **QPA206...**

- For the temperature measuring range:
  - Jumper in the upper position (R1) = -35...+35 °C
  - Jumper in the mid position (R2) = 0...50 °C (factory setting)

|  |   |
|--|---|
| ...for output voltage for all <b>QPA...</b>              | <ul style="list-style-type: none"> <li>• <i>As per listing above R3 or R4 (depending on the device):</i> <ul style="list-style-type: none"> <li>– Plugged in jumper = DC 0...10 V</li> <li>– Removed jumper = DC 0...5 V</li> </ul> </li> </ul>   |
| ... for the active test function                         | <p>Jumper for the measuring range in the vertical position:<br/>The signal output delivers the values according to table "Test function active".</p>  |
| ... for selection of the temperature unit on the display | <ul style="list-style-type: none"> <li>• <i>For the unit of temperature:</i> <ul style="list-style-type: none"> <li>– Jumper in the horizontal, lower position = °C (factory setting)</li> <li>– Jumper in the horizontal, upper position = °F</li> </ul> </li> </ul>   |
| <b>Behavior in the event of fault</b>                    |   |
| <b>QPA1...</b>   | <ul style="list-style-type: none"> <li>• In the event of VOC failure, DC 10 V or 5 V is present at signal output U1 (after 60 seconds).</li> </ul>  |
| <b>QPA2...</b>   | <ul style="list-style-type: none"> <li>• In the event of CO<sub>2</sub> failure, DC 10 V or 5 V is present at signal output U1 (after 60 seconds).</li> </ul>   |
| <b>QPA2002</b>   | <ul style="list-style-type: none"> <li>• In the event of CO<sub>2</sub> or VOC failure, DC 10 V or 5 V is present at signal output U2 (after 60 seconds).</li> </ul>  |
| <b>QPA2060 and QPA2060D</b>                              | <ul style="list-style-type: none"> <li>• If the temperature sensor becomes faulty, 0 V is present at signal output U2.</li> </ul>   |
| <b>QPA2062 and QPA2062D</b>                              | <ul style="list-style-type: none"> <li>• If the temperature sensor becomes faulty, 0 V is present at signal output U3, and the humidity signal at signal output U2 increases to DC 10 V or 5 V (after 60 seconds).</li> <li>• If the humidity sensor becomes faulty, DC 10 V or 5 V is present at signal output U2 (after 60 seconds), and the temperature signal remains active.</li> </ul>  |
| <b>Display of measured values</b>                        | <p>With sensors type <b>QPA2002D</b>, <b>QPA2060D</b> and <b>QPA2062D</b>, the measured values can be read on an LCD. The following measured values are displayed:</p> <ul style="list-style-type: none"> <li>– CO<sub>2</sub> : In ppm</li> <li>– CO<sub>2</sub> + VOC: As a bar chart: 4 bars <math>\hat{=}</math> U2 = 2 V,<br/>20 bars <math>\hat{=}</math> U2 = 10 V or 5 V)</li> <li>– Temperature: In °C or °F</li> <li>– Humidity: In % r.h.</li> </ul> <p>The passive, measured temperature value cannot be displayed on type <b>QPA2080D</b>.</p> |

## Engineering notes

---

Room sensors with active outputs have a high power loss, which can influence temperature measurement.

The measuring accuracy is impacted by the following factors:

- Prevailing air flow
- Wall surface (rough, smooth)
- Wall texture (wood, plaster, concrete, brick)
- Wall type (interior, exterior).

This application-specific measuring inaccuracy is constant for an installed sensor after approx. 1 operating hour, and it can be adjusted as needed in a higher system (e.g. controller). No correction on the local LCD.

The sensor must be powered by a transformer for safety extra low-voltage (SELV) with separate windings, suited for 100 % duty. Size and fuse it in compliance with local safety regulations.

When sizing the transformer, consider the power consumption of the sensor. For information about wiring, see the data sheets of the devices with which the sensor is used. Observe maximum permissible cable lengths.

Cable routing and cable selection

When laying the cables, remember that electrical interference is greater the longer the cables run parallel and the smaller the distance between them. On applications with EMC problems, use shielded cables. For secondary power lines and signal lines, use twisted-pair cables.

---

## Mounting notes

|                       |   |
|-----------------------|---|
| Mounting location     | Inner wall of the room to be ventilated, not in niches, not behind curtains, not above or near heat sources, and not exposed to direct light from spot lights.<br>Do not expose the sensor to direct solar radiation.<br>Seal the end of the conduit at the sensor to prevent false measurements due to drafts through the conduit. |
| Mounting instructions | Mounting instructions are enclosed in the package.  |

## Commissioning notes

The sensor's functions can be checked 30 minutes after applying power:

- Checking the CO<sub>2</sub> function:  
In well ventilated rooms, the sensor shows the CO<sub>2</sub> concentration of the outside air. This is typically 360 ppm (the sensor's measuring accuracy must be considered). Also, a basic functional check can be made by exhaling on the sensor. In this case, remember that the sensor's rate of response is purposely delayed (time constant  $t_{63}$  = 5 min).
- Checking the VOC function:  
Touch the sensor with a cotton ball dowsed in alcohol (e.g. gas from a cigarette lighter, without lighting a flame).

Ventilation should start when the preset switching level of the connected controller is reached.

After applying power to the types of sensor with display, Init appears for about 6 seconds.

## Disposal



The devices are considered electronics devices for disposal in term of European Directive 2012/19/EU and may not be disposed of as domestic waste.

- Dispose of the device via the channels provided for this purpose.
- Comply with all local and currently applicable laws and regulations.

## Technical data

|                                    |   |  |
|------------------------------------|---|--|
| Power supply                       | Operating voltage                                 | AC 24 V $\pm$ 20 % oder DC 15...35 V (SELV)<br>oder<br>AC/DC 24 V class 2 (US)   |
|                                    | Frequency   | 50/60 Hz at AC 24 V  |
|                                    | External supply line protection (EU)              | Fuse slow max. 10 A<br>or<br>Circuit breaker max. 13 A<br>Characteristic B, C, D according to<br>or<br>Power source with current limitation of max.<br>10 A  |
|                                    | Power consumption                                 | QPA1000 < 0.8 VA<br>QPA2000, QPA2060, QPA2060D, QPA2062, QPA2062D < 1.7 VA, typ. < 0.5 VA<br>QPA 2080, QPA2080D<br>QPA2002, QPA2002D < 2.3 VA, typ. < 1.0 VA |
| Cable lengths for measuring signal | Perm. cable lengths                               | See data sheet of the device handling the signal   |
| Functional data "CO <sub>2</sub> " | Measuring range (MW = measured value)             | 0...2000 ppm   |
|                                    | Measuring accuracy at 23 °C and 1013 hPa          | $\leq \pm$ (50 ppm + 2 % MW)   |
|                                    | Temperature dependency in the range of -5...45 °C | $\pm$ 2 ppm / °C (typically)   |
|                                    | Long-time drift                                   | $\leq \pm$ 20 ppm p.a. (typically)   |
|                                    | Time constant $t_{63}$                            | < 5 min  |
|                                    | Output signal, linear (terminal U1)               | DC 0...10 V or DC 0...5 V $\hat{=}$ 0...2000 ppm,<br>max. $\pm$ 1 mA   |
| Functional data "VOC"              | Recalibration-free                                | 8 years  |
|                                    | Measuring range                                   | 0...100% VOC   |



|   |  |   |
|---|--|---|
|   | Time constant $t_{63}$ VOC (CO <sub>2</sub> see above) | <13 min (R1), <3.5 min (R2), <1 min (R3)  |
| Functional data "Maximum selection from CO <sub>2</sub> and VOC" for QPA2002 and QPA2002D<br>Functional data "Rel. Humidity" for QPA2062 and QPA2062D | Output signal, linear (terminal U1)                    | DC 0...10 V or DC 0...5 V $\hat{=}$ 0...100%, max. $\pm$ 1 mA   |
|   | Output signal, linear (terminal U2)                    | DC 0...10 V or DC 0...5 V $\hat{=}$ max. of 0...2000 ppm, CO <sub>2</sub> or 0...100% VOC, max. $\pm$ 1 mA  |
|   | Range of use   | 0...95 % r.h. (non-condensing)  |
|   | Measuring range  | 0...100 % r.h.  |
|   | Measuring accuracy at 23 °C and AC 24 V                |   |
|   | 0...95 % r.h.  | $\pm$ 5 % r.h.  |
|   | 30...70 % r.h.   | $\pm$ 3 % r.h. (typically)  |
|   | Temperature dependency                                 | $\leq$ 0.1 % r.h./°C  |
|   | Time constant  | approx. 20 s  |
|   | Output signal, linear (terminal U2)                    | DC 0...10 V or DC 0...5 V $\hat{=}$ 0...100 % r.h., max. $\pm$ 1 mA   |
| Functional data "Temperature" with QPA206...  | Measuring range  | 0...50 °C (R2, R3) or -35...+35 °C (R1)   |
|   | Measuring accuracy at AC 24 V in the range of          |   |
|   | 23 °C  | $\pm$ 0.3 K   |
|   | 15...35 °C   | $\pm$ 0.8 K   |
|   | -35...+50 °C   | $\pm$ 1 K   |
| Functional data "Temperature" with QPA208...  | Time constant $t_{63}$                                 | 8.5 min   |
|   | Sensing range  | see "Mode of operation"   |
|   | Measuring accuracy                                     | see "Mode of operation"   |
|   | Time constant $t_{63}$                                 | 8.5 min   |
|   | Correction Intrinsic heat                              | 1.4 K (typically)   |
|   | Output signal (terminal B, M)                          | passive   |
| Display of measured value<br>Degree of protection   | With QPA2002D, QPA2060D, QPA2062D, QPA2080D            | LCD   |
|   | Protection degree of housing                           | IP30 according to EN 60529  |
|   | Protection class                                       | III according to EN 60730-1   |
| Electrical connections  | Screw terminals for                                    | 1 $\times$ 2.5 mm <sup>2</sup> or 2 $\times$ 1.5 mm <sup>2</sup>  |
| Environmental conditions  | Operation to   | IEC 60721-3-3   |
|   | Climatic conditions                                    | Class 3K3   |
|   | Temperature (housing incl. electronics)                | 0...50 °C   |
|   | Humidity   | 0...95 % r.h. (non-condensing)  |
|   | Mechanical conditions                                  | class 3M2   |
|   | Transport to   | IEC 60721-3-2   |
|   | Climatic conditions                                    | Class 2K3   |
|   | Temperature  | -25...+70 °C  |
|   | Humidity   | <95 % r.h.  |
|   | Mechanical conditions                                  | Class 2M2   |
| Materials and colors  | Cover  | ASA + PC, NCS S 0502-G (white) equates to RAL9010   |
|   | Housing  | ASA + PC, NCS 2801-Y43R (grey) equates to RAL7035   |
|   | Mounting plate   | PC, NCS 2801-Y43R (grey) equates to RAL7035   |
|   | Sensor (complete)                                      | Silicone-free   |
|   | Packaging  | Corrugated cardboard  |
| Directives and Standards  | Product standard                                       | EN 60730-1<br>Automatic electrical controls for household and similar use   |
|   | Electromagnetic compatibility (Applications)           | For use in residential, commerce, light-industrial and industrial environments  |
|   | EU Conformity (CE)                                     | CE1T1961xx <sup>1)</sup>  |
|   | RCM Conformity   | CE1T1961en_C1 *)  |
|   | UL   |   |
|   | Environmental compatibility                            | The product environmental declaration CE1E1961 <sup>1)</sup> contains data on environmentally compatible product design and assessments (RoHS compliance, materials composition, packaging, environmental benefit, disposal). |
| Weight  | Incl. packaging  |   |
|   | Without display  | approx. 0.10 kg   |
|   | With display   | approx. 0.12 kg   |

**QPA1000**

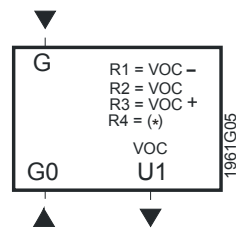

**QPA2000**

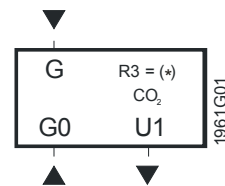

**QPA2002, QPA2002D**

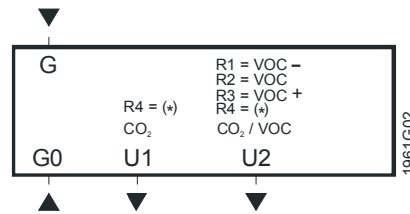

**QPA2060, QPA2060D**

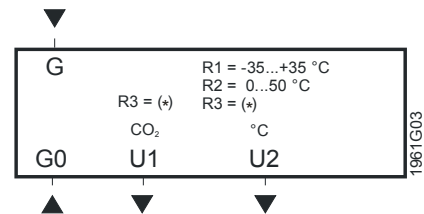

**QPA2062, QPA2062D**

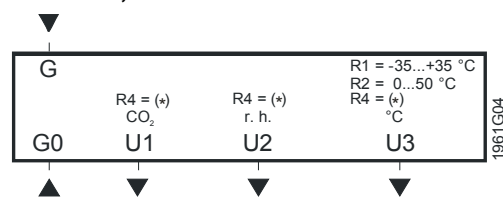

**QPA2080, QPA2080D**

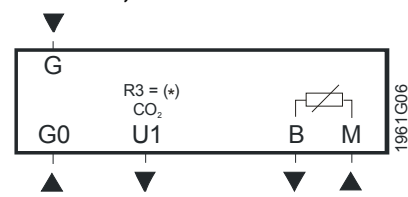

- G System potential AC 24 V (SELV) or DC 15...35 V
- G0 System neutral and measuring neutral
- U1 Signal output DC 0...10 V or DC 0...5 V
- U2 Signal output DC 0...10 V or DC 0...5 V
- U3 Signal output DC 0...10 V or DC 0...5 V
- R...(\*) Signal output with R... = DC 0...10 V
- Signal output without R... = DC 0...5 V
- B, M Passive temperature output (interchangeable)

**Dimensions**

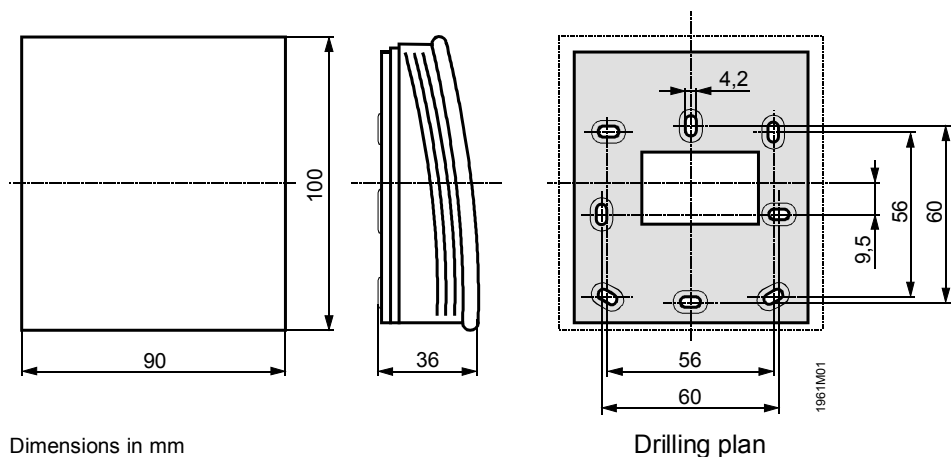

Dimensions in mm

Drilling plan

Архангельск (8182)63-90-72  
 Астана +7(7172)727-132  
 Белгород (4722)40-23-64  
 Брянск (4832)59-03-52  
 Владивосток (423)249-28-31  
 Волгоград (844)278-03-48  
 Вологда (8172)26-41-59  
 Воронеж (473)204-51-73  
 Екатеринбург (343)384-55-89  
 Иваново (4932)77-34-06  
 Ижевск (3412)26-03-58  
 Казань (843)206-01-48

Калининград (4012)72-03-81  
 Калуга (4842)92-23-67  
 Кемерово (3842)65-04-62  
 Киров (8332)68-02-04  
 Краснодар (861)203-40-90  
 Красноярск (391)204-63-61  
 Курск (4712)77-13-04  
 Липецк (4742)52-20-81  
 Магнитогорск (3519)55-03-13  
 Москва (495)268-04-70  
 Мурманск (8152)59-64-93  
 Набережные Челны (8552)20-53-41

Нижний Новгород (831)429-08-12  
 Новокузнецк (3843)20-46-81  
 Новосибирск (383)227-86-73  
 Орел (4862)44-53-42  
 Оренбург (3532)37-68-04  
 Пенза (8412)22-31-16  
 Пермь (342)205-81-47  
 Ростов-на-Дону (863)308-18-15  
 Рязань (4912)46-61-64  
 Самара (846)206-03-16  
 Санкт-Петербург (812)309-46-40  
 Саратов (845)249-38-78

Смоленск (4812)29-41-54  
 Сочи (862)225-72-31  
 Ставрополь (8652)20-65-13  
 Тверь (4822)63-31-35  
 Томск (3822)98-41-53  
 Тула (4872)74-02-29  
 Тюмень (3452)66-21-18  
 Ульяновск (8422)24-23-59  
 Уфа (347)229-48-12  
 Челябинск (351)202-03-61  
 Череповец (8202)49-02-64  
 Ярославль (4852)69-52-93