



Solar Impact Sensor

QLS60

- Sensor for acquiring the impact of solar radiation
- Output signal DC 0...10 V
- 2-wire current output 4...20 mA

Use

The solar impact sensor is used as a reference sensor in heating, ventilation and air conditioning plants where compensation of solar radiation is required. Solar compensation is necessary where buildings or building sections with large window areas are subjected to strong solar radiation, especially in plants where thermostatic radiator valves cannot be used.

Ordering

When ordering, please give name and type reference: Solar impact sensor **QLS60**

Equipment combinations

The sensor can be used in connection with all types of systems and devices capable of acquiring and handling the sensor's 4...20 mA or DC 0...10 V output signal.

Technical design

To determine the impact of solar radiation, the sensor uses a solar cell which acquires the level of radiation. That cell generates an electrical current depending on the extent of radiation, which is then evaluated by the sensor. As a result, the sensor delivers an output signal of 4...20 mA or DC 0...10 V, which is proportional to the solar radiation range.

Архангельск (8182)63-90-72
Астана +7(7172)727-132
Белгород (4722)40-23-64
Брянск (4832)59-03-52
Владивосток (423)249-28-31
Волгоград (844)278-03-48
Вологда (8172)26-41-59
Воронеж (473)204-51-73
Екатеринбург (343)384-55-89
Иваново (4932)77-34-06
Ижевск (3412)26-03-58
Казань (843)206-01-48

Калининград (4012)72-03-81
Калуга (4842)92-23-67
Кемерово (3842)65-04-62
Киров (8332)68-02-04
Краснодар (861)203-40-90
Красноярск (391)204-63-61
Курск (4712)77-13-04
Липецк (4742)52-20-81
Магнитогорск (3519)55-03-13
Москва (495)268-04-70
Мурманск (8152)59-64-93
Набережные Челны (8552)20-53-41

Нижний Новгород (831)429-08-12
Новокузнецк (3843)20-46-81
Новосибирск (383)227-86-73
Орел (4862)44-53-42
Оренбург (3532)37-68-04
Пенза (8412)22-31-16
Пермь (342)205-81-47
Ростов-на-Дону (863)308-18-15
Рязань (4912)46-61-64
Самара (846)206-03-16
Санкт-Петербург (812)309-46-40
Саратов (845)249-38-78

Смоленск (4812)29-41-54
Сочи (862)225-72-31
Ставрополь (8652)20-65-13
Тверь (4822)63-31-35
Томск (3822)98-41-53
Тула (4872)74-02-29
Тюмень (3452)66-21-18
Ульяновск (8422)24-23-59
Уфа (347)229-48-12
Челябинск (351)202-03-61
Череповец (8202)49-02-64
Ярославль (4852)69-52-93

Mechanical design

The solar impact sensor is designed for wall mounting. The cable must be introduced from the bottom.

The sensor consists of plastic housing with a transparent cover and a Pg 9 cable entry gland.

The solar cell is located in the cover, the sensor electronics with the connection terminals inside the housing. The cover is secured to the housing with 2 screws and can be removed. A rubber seal is used between housing and cover to ensure degree of protection IP 65. The measured values from the photocell to the sensor electronics are transmitted via a 2-wire connection.

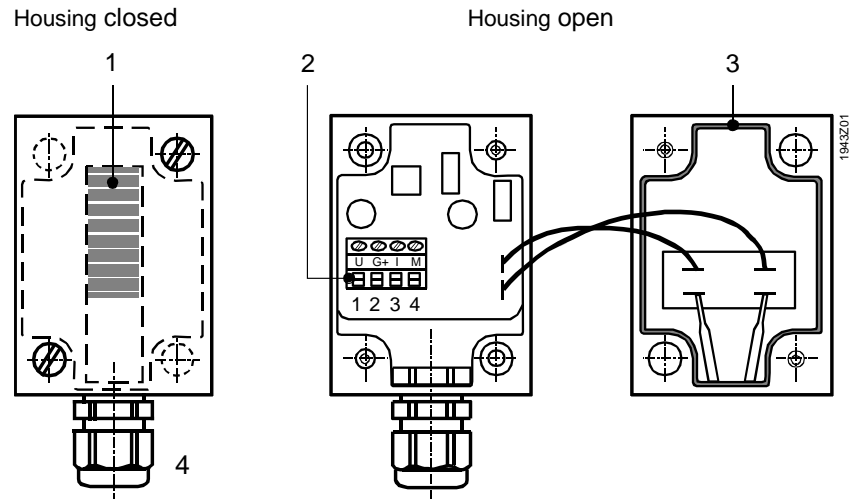

Legend

- 1 Solar cell
- 2 Connection terminals
- 3 Rubber seal
- 4 Sealing gland (conduit adapter supplied for US / Asia Pacific)

Engineering notes

The correct mounting location of the sensor is decisive for achieving the desired effect. It must be determined by the planning engineer. The information given in section "Mounting and installation notes" must be observed.

Power supply line and measuring line must be run together.

The voltage output can be used only if the current output is not required. Mixed operation is not possible. The measuring voltage is calculated as follows:

$$U = E \cdot \frac{10 \text{ V}}{1000 \text{ W / m}^2}$$

where E = solar radiation in W / m^2

When using the current output, the voltage output cannot be used. The electronic circuit receives its power from the current supply. For that, the current measuring voltage must lie in the range of DC 15...30 V. The measuring current is calculated as follows:

$$I = 4 \text{ mA} + E \cdot \frac{16 \text{ mA}}{1000 \text{ W / m}^2}$$

where E = solar radiation in W / m^2

Fitting and installation notes

When deciding on the mounting location, it should first be determined for which part of the building (heating zone) the sensor shall acquire the solar radiation. It must be located on the wall having the windows of the rooms that are affected by solar radiation.

This is, in general:

- The wall of the heating zone with the window area which receives the largest part of solar radiation for the longest period of time
- As high as possible, but at least 3 m above the ground
- Easily accessible (to facilitate checking), approximately 30 cm beside a window

Note:

Not in the shade of trees, houses, telephone poles, etc.
The sensor must not be painted over.

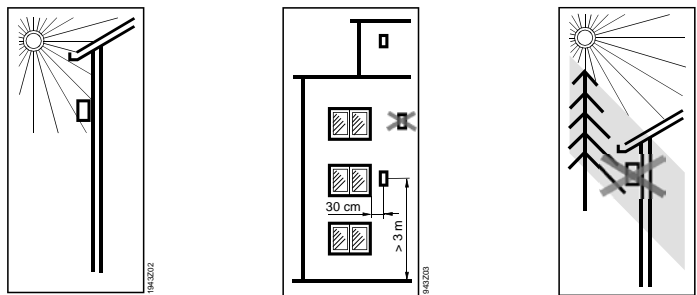

The solar impact sensor is supplied complete with Mounting Instructions.

Commissioning notes

When commissioning the plant, the wiring must be checked. No settings can be made on the sensor itself.

Disposal



The devices are considered electronics devices for disposal in terms of European Directive 2012/19/EU and may not be disposed of as domestic waste.

- Dispose of the device via the channels provided for this purpose.
- Comply with all local and currently applicable laws and regulations.

Technical data

Power supply (G+, M)	Rated voltage range	AC 24 V \pm 20 % (SELV) or DC 24 V (18...30 V) (SELV)
	Rated frequency at AC 24 V	50/60 Hz
	Rated power consumption	max. 2.5 VA (1 W)
	External supply line protection	Fuse slow max. 10 A or Circuit breaker max. 13 A Characteristic B, C, D according to EN 60898 or Power source with current limitation of max. 10 A
Range of use	Measuring range	0...1000 W/m ²
Functional data	Time constant t ₆₃	≤2 s
Measured value outputs (U, I)	Voltage signal output (U)	DC 0...10 V \cong 0...1000 W/m ²
	Current signal output (I)	4...20 mA \cong 0...1000 W/m ²
	Perm. cable lengths with copper cable	
	1.0 mm ²	50 m
1.5 mm ²	150 m	
2.5 mm ²	300 m	
Electrical connections	Screw terminals for	2 x 1.5 mm ² or 1 x 2.5 mm ²
Degree of protection	Protection degree of housing	IP65 according to EN 60529
	Protection class	III according to EN 60730
Environmental conditions	Operation to	IEC 60721-3-3
	Climatic conditions	Class 3K5
	Temperature	-25...+55 °C
	Humidity (noncondensing)	5...95 % r. h.
	Mechanical conditions	Class 3M2
	Transportation to	IEC 60721-3-2
Climatic conditions	Class 2K3	
Temperature	-25...+70 °C	
Humidity	<95 % r. h.	
Mechanical conditions	Class 2M2	
Directives and Standards	Product standard	EN 61326-1 Electrical equipment for measurement, control and laboratory use.
	EU Conformity (CE)	CE1T1943xx ¹⁾
Environmental compatibility	The product environmental declaration CE1E1943 ¹⁾ contains data on environmentally compatible product design and assessment (RoHS compliance, materials composition, packaging, environmental benefit, disposal).	
Materials and colors	Housing	Polycarbonate / RAL 9002 (gray-white)
	Housing cover	Polycarbonate (transparent), solar panel moulded in silicone / RAL9010
	Packaging	cardboard
Weight	Without packaging	approx. 0.124 kg

Connection diagrams

Internal diagrams

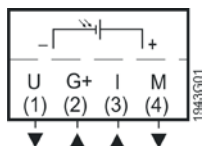

G+ Operating voltage AC 24 V or DC 24 V (DC 18...30 V)
 M Measuring neutral (power supply and signal), Solar radiation measuring signal 4...20 mA
 U Solar radiation measuring signal DC 0...10 V
 I Operating voltage DC 24 V (DC 18...30 V)

Connection diagrams

Voltage measurement with AC supply:

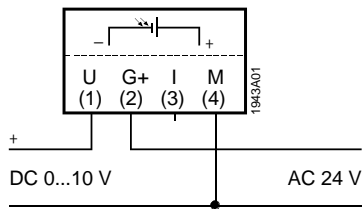

DC supply:

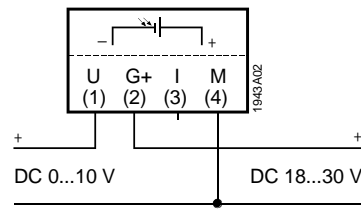

Current measurement:

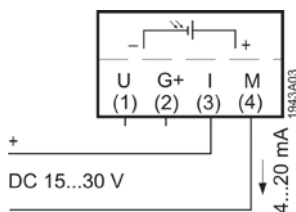

Dimensions

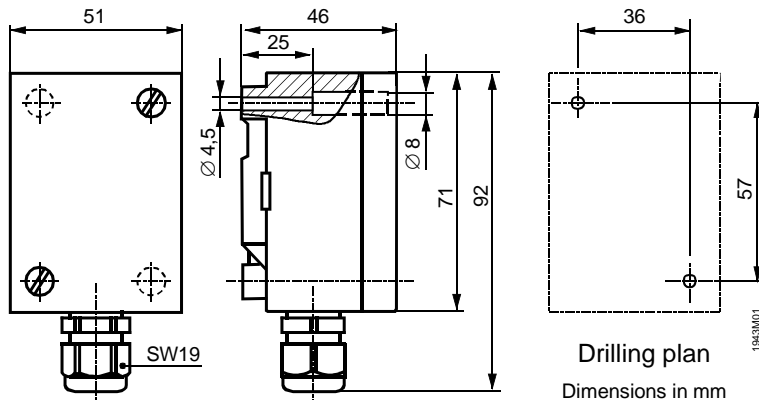

Архангельск (8182)63-90-72
 Астана +7(7172)727-132
 Белгород (4722)40-23-64
 Брянск (4832)59-03-52
 Владивосток (423)249-28-31
 Волгоград (844)278-03-48
 Вологда (8172)26-41-59
 Воронеж (473)204-51-73
 Екатеринбург (343)384-55-89
 Иваново (4932)77-34-06
 Ижевск (3412)26-03-58
 Казань (843)206-01-48

Калининград (4012)72-03-81
 Калуга (4842)92-23-67
 Кемерово (3842)65-04-62
 Киров (8332)68-02-04
 Краснодар (861)203-40-90
 Красноярск (391)204-63-61
 Курск (4712)77-13-04
 Липецк (4742)52-20-81
 Магнитогорск (3519)55-03-13
 Москва (495)268-04-70
 Мурманск (8152)59-64-93
 Набережные Челны (8552)20-53-41

Нижний Новгород (831)429-08-12
 Новокузнецк (3843)20-46-81
 Новосибирск (383)227-86-73
 Орел (4862)44-53-42
 Оренбург (3532)37-68-04
 Пенза (8412)22-31-16
 Пермь (342)205-81-47
 Ростов-на-Дону (863)308-18-15
 Рязань (4912)46-61-64
 Самара (846)206-03-16
 Санкт-Петербург (812)309-46-40
 Саратов (845)249-38-78

Смоленск (4812)29-41-54
 Сочи (862)225-72-31
 Ставрополь (8652)20-65-13
 Тверь (4822)63-31-35
 Томск (3822)98-41-53
 Тула (4872)74-02-29
 Тюмень (3452)66-21-18
 Ульяновск (8422)24-23-59
 Уфа (347)229-48-12
 Челябинск (351)202-03-61
 Череповец (8202)49-02-64
 Ярославль (4852)69-52-93